

OMRON®

INSTRUCTION MANUAL

COMP *Air*® *Elite*

Compact Compressor Nebulizer

MODEL NE-C30

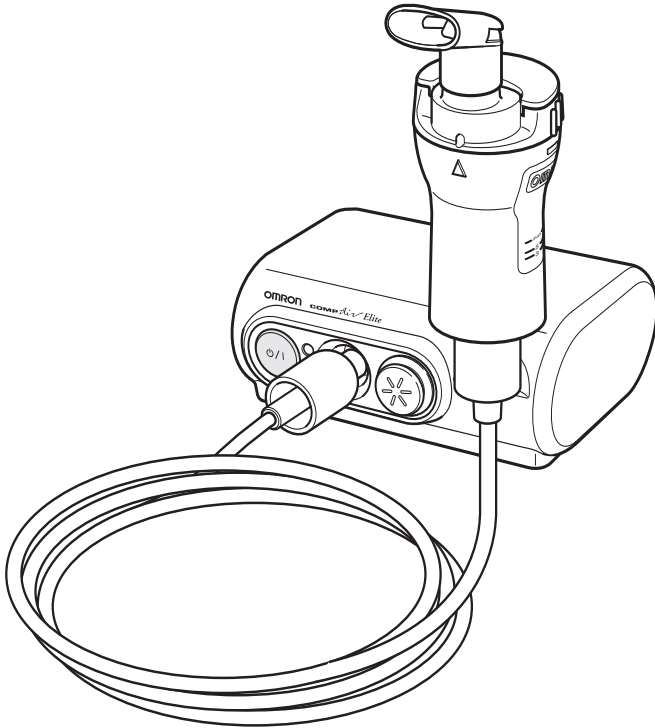

Caution: Federal (USA) law restricts this device to sale by or on the order of a physician or licensed healthcare practitioner

PORTUGUÊS

ESPAÑOL

ENGLISH

CONTENTS

Before Using the Device

Introduction	3
Safety Information	
Operating the Device	4
Risk of Electrical Shock	6
Maintenance and Storage	7
Know Your Unit	
Main Unit	8
Components and Replacement Parts	8

Operating Instructions

Preparing the Nebulizer for Use	10
Attaching the Air Tube	13
Using the Device	14

Care and Maintenance

Cleaning after Each Use	17
Daily Disinfecting	18
Changing the Air Filter	20
Caring for the Device	21

Troubleshooting

Troubleshooting Guide	23
Warranty	24
FCC Statement	25
Specifications	26
Notes	27

The illustrations shown in this instruction manual are image drawings and may differ slightly from the appearance of the actual product.

INTRODUCTION

Thank you for purchasing the OMRON® NE-C30 Compact Compressor Nebulizer.

Fill in for future reference.

DATE PURCHASED: _____

SERIAL NUMBER: _____

Staple your purchase receipt here

This product was developed for the successful treatment of asthma, allergies and other respiratory disorders. The compressor forces air to the nebulizer. When the air enters the nebulizer, it converts the prescribed medication into an aerosol of microscopic droplets that can easily be inhaled.

Your NE-C30 CompAir® Elite comes with the following components:

- Compressor (Main Unit)
- AC Adapter
- Carrying Bag
- Air Tube
- Air Filters (Package of 5)
- Air Filter Cover
- Child Mask
- Mouthpiece
- Nebulizer Kit
- Instruction Manual (English, Spanish, Portuguese)
- Instructional DVD
- User Registration Card

The following are optional accessories sold separately:



- Adult Mask
- Nosepiece
- Rechargeable Battery
- Battery Charger

The CompAir® Elite is a prescription medical device. Operate this device only as instructed by your physician and/or licensed healthcare practitioner.













SAVE THESE INSTRUCTIONS

SAFETY INFORMATION

To assure the correct use of the product basic safety measures should always be followed including the warnings and cautions listed in this instruction manual.

SAFETY SYMBOLS USED IN THIS INSTRUCTION MANUAL	
 WARNING	Indicates a potentially hazardous situation which, if not avoided, could result in death or serious injury.
 CAUTION	Indicates a potentially hazardous situation which, if not avoided, may result in minor or moderate injury to the user or patient or damage to the equipment or other property.

OPERATING THE DEVICE

-  For type, dose, and regime of medication follow the instructions of your physician or licensed healthcare practitioner.
-  Pentamidine is not an approved medication for use with this device.
-  Do not cover the compressor with a blanket, towel, or any other type of cover during use. This could result in the compressor overheating or malfunctioning.
-  When using the optional rechargeable battery always fully charge the battery using the battery charger designed for this device. If the battery is frequently used without being fully charged, the capacity of the battery will be reduced and the device may stop during use. In this case, use the AC adapter to continue using the device.
-  Do not use the device where the device may be exposed to flammable gas or vapors.
-  Do not use tap or mineral water in the nebulizer for nebulizing purposes.
-  Clean and disinfect the nebulizer kit, mouthpiece, and optional nosepiece or masks before using them for the first time after purchase.
-  If the device has not been used for a long period of time clean and disinfect the nebulizer kit, mouthpiece, and optional nosepiece or masks before using them.
-  Always dispose of any remaining medication in the medication cup after each use. Use fresh medication each time you use the device.
-  Do not leave the device or its parts where it will be exposed to extreme temperatures or changes in humidity, such as leaving the device in a vehicle during warm or hot months, or where it will be exposed to direct sunlight.
-  Limit the use of the device to 20 minutes at a time, and wait 40 minutes before using the device again.
-  Provide close supervision when this device is used by, on, or near infants, children or compromised individuals.

IMPORTANT SAFETY NOTES

OPERATING THE DEVICE (continued)

- ⚠ Do not insert any object into the compressor.
- ⚠ Make sure the air filter is clean. If the air filter has changed color or has not been used for 60 days, replace the filter.
- ⚠ Make sure the nebulizer kit is correctly assembled, the air filter is properly installed, and the air tube is correctly connected to the compressor and the nebulizer kit. Air may leak from the air tube during use if not securely connected.
- ⚠ Inspect the compressor (main unit) and the nebulizer parts each time before using the device. Make sure no parts are damaged, the nozzle and air tube are not blocked and the compressor operates normally.
- ⚠ Do not use the device if the air tube is bent.
- ⚠ Do not block the air filter cover.
- ⚠ Do not alter the baffle, the nozzle in the medication cup or any part of the nebulizer kit.
- ⚠ Do not add more than 7ml of medication to the medication cup.
- ⚠ Do not operate the device at temperatures greater than +104°F (+40°C).
- ⚠ Do not tilt the nebulizer kit so the angle of the kit is greater than 45°. Medication may flow into the mouth.
- ⚠ Do not shake the nebulizer kit while using the device.
- ⚠ Do not subject the compressor, rechargeable battery, battery charger or any of the components to strong shocks, such as dropping on the floor.
- ⚠ This device is approved for human use only.
- ⚠ Do not disassemble or attempt to repair the device or components.
- ⚠ Operate the device only as intended. Do not use the device for any other purpose.
- ⚠ Dispose of the device, components and optional accessories according to applicable local regulations. Unlawful disposal may cause environmental pollution.
- ⚠ Use only Omron authorized parts and accessories. Parts and accessories not approved for use with the device may damage the unit.
- ⚠ Changes or modification not approved by Omron Healthcare will void the user warranty.
- ⚠ Make sure that the air tube is securely attached to the compressor (main unit) and nebulizing parts, and does not come loose. Twist the air tube slightly when inserting it into the connectors to avoid the tube disconnecting during use.

IMPORTANT SAFETY NOTES

RISK OF ELECTRICAL SHOCK

- ⚠ Do not connect the battery connector located on the bottom of the main unit to the rechargeable battery terminal using wire or other metallic conductors.
- ⚠ Do not use the compressor (main unit), AC adapter, rechargeable battery or battery charger while they are wet.
- ⚠ Do not plug or unplug the power cord into the electrical outlet with wet hands.
- ⚠ Do not immerse the compressor (main unit) in water or other liquid.
- ⚠ Do not spill water or other liquids on the compressor, AC adapter, rechargeable battery and battery charger. These parts are not waterproof. If liquid spills on these parts, immediately unplug the power cord and wipe off the liquid with gauze or other soft absorbent material.
- ⚠ Do not use or store the device in humid locations, such as a bathroom. Use the device within the operating temperature and humidity.
- ⚠ Do not place metal objects, such as hair pins, in the carrying bag with device and the rechargeable battery.
- ⚠ Use only the AC adapter designed by Omron for this device. Use of any other AC adapter may damage the device.
- ⚠ Do not use a cellular phone near the device. It may result in an operational failure.
- ⚠ Do not overload power outlets. Plug the device into the appropriate voltage outlet.
- ⚠ Do not use extension cords. Plug the power cord directly into the electrical outlet.
- ⚠ Unplug the power cord from the electrical outlet after using the device.
- ⚠ Remove the rechargeable battery and the AC Adaptor from the device after use.
- ⚠ Unplug the power cord from the electrical outlet before cleaning the device.
- ⚠ Completely read all of the instructions included with the optional accessories, such as the rechargeable battery and battery charger, before using them.

IMPORTANT SAFETY NOTES

MAINTENANCE AND STORAGE

- ⚠ Keep the device out of the reach of unsupervised infants and children. The device may contain small parts that can be swallowed.
- ⚠ Do not leave the cleaning solution in the nebulizer parts. Rinse the nebulizer parts with clean hot tap water after disinfecting.
- ⚠ Wash the nebulizer parts after each use. Dry the parts immediately after washing.
- ⚠ Do not store the air tube with moisture or medication remaining in the air tube. This could result in infection as a result of bacteria.
- ⚠ Store the device and the components in a clean, safe location.
- ⚠ Do not carry or leave the nebulizer with medication in the medication cup.
- ⚠ Do not place or attempt to dry the device, components or any of the nebulizer parts in a microwave oven.
- ⚠ Do not wrap the power cord around the compressor (main unit).

KNOW YOUR UNIT

Main Unit:

Compressor

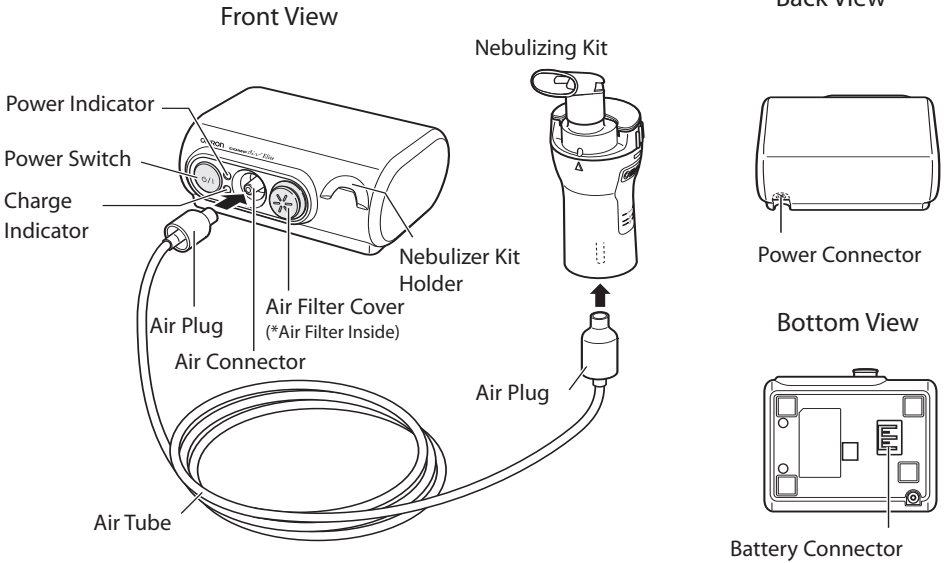

Components:

Nebulizer Kit

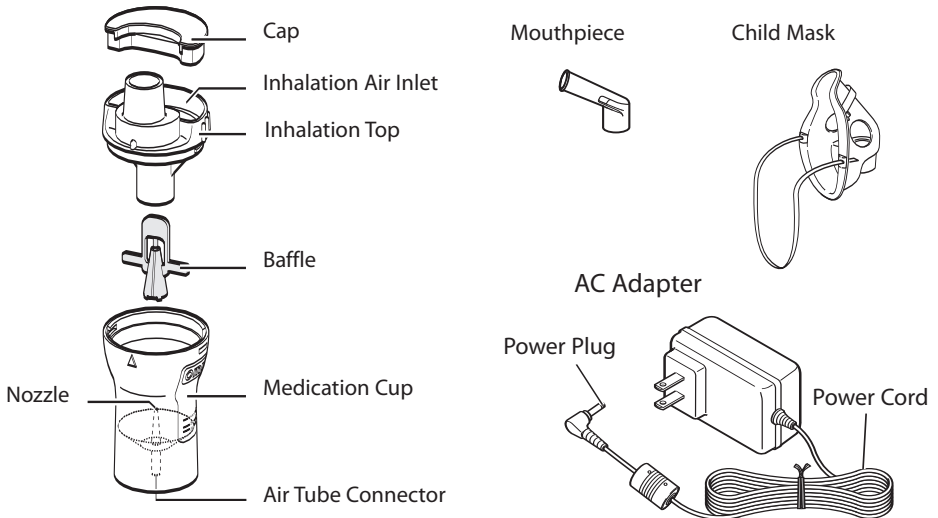

KNOW YOUR UNIT

Components:

Air Tube
with attached Air Plugs

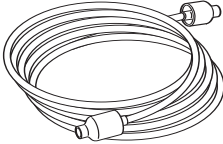

Air Filters
Package of 5

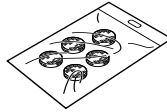

Air Filter Cover



Instruction Manual

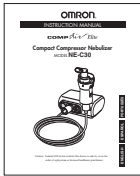

User Registration Card



Carrying Bag



Instructional DVD



Optional Accessories:

Adult Mask



Nosepiece



Rechargeable
Battery

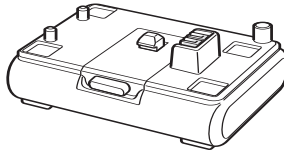

Battery
Charger

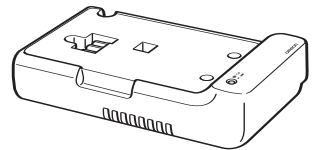

Accessories and Replacement Parts

	Model No.
AC Adapter	C30AC
Adult Mask	C920
Air Filters (Package of 5)	C30FL
Air Tube with attached Air Plugs	C915
Carrying Bag	C30BAG
Child Mask	C922
Nebulizer Kit Set	C900
Includes Nebulizer Kit, Mouthpiece and Air Tube	
Nosepiece	C911
Mouthpiece	C910
Battery Set	C30BATSET
Includes Rechargeable Battery and Battery Charger	
Rechargeable Battery	C30BAT
Battery Charger	C30BATC

PREPARING THE NEBULIZER FOR USE

⚠ WARNING

Clean and disinfect the nebulizer kit, mouthpiece, and optional nosepiece or masks before using them for the first time after purchase.

⚠ WARNING

If the device has not been used for a long period of time clean and disinfect the nebulizer kit, mouthpiece, and optional nosepiece or masks before using them.

For directions on cleaning and disinfecting refer to page 17 and page 18.

⚠ CAUTION

Make sure the air filter is clean. If the air filter has changed color or has not been used for 60 days, replace the filter.

For directions on changing the air filter refer to page 20.

1. Insert the power plug on the AC adapter into the power connector on the back side of the compressor. Plug the AC adapter into the electrical outlet.

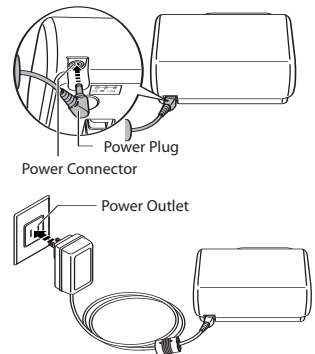

⚠ WARNING

Do not plug or unplug the power cord into the electrical outlet with wet hands.

⚠ CAUTION

Do not overload power outlets. Plug the device into the appropriate voltage outlet.

⚠ CAUTION

Do not use extension cords. Plug the power cord directly into the electrical outlet.



2. Lift up the mouthpiece and the cap to remove them from the nebulizer kit.
3. Rotate the inhalation top counterclockwise (A) and lift (B) to remove the inhalation top from the medication cup.

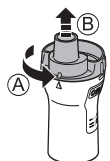

PREPARING THE NEBULIZER FOR USE

- Lift up the baffle and remove the baffle from the medication cup.



⚠ CAUTION

Do not alter the baffle, the nozzle in the medication cup or any part of the nebulizer kit.

- Add the correct amount of prescribed medication to the medication cup.



⚠ WARNING

Pentamidine is not an approved medication for use with this device.

⚠ WARNING

For type, dose, and regime of medication follow the instructions of your physician or licensed healthcare practitioner.

⚠ WARNING

Do not spill water or other liquids on the compressor and power cord. The compressor and power cord are not waterproof. If liquid spills on these parts, immediately unplug the power cord and wipe off the liquid with gauze or other soft absorbent material.

⚠ WARNING

Do not use tap or mineral water in the nebulizer for nebulizing purposes.

⚠ CAUTION

Do not add more than 7ml of medication to the medication cup.

- Place the baffle back into the medication cup. Make sure the baffle is correctly positioned over the nozzle in the medication cup.



- Place the inhalation top on the medication cup over the baffle. The top of the baffle should be centered in the inhalation top.

Align the protrusion on the inhalation top with the indentation on the medication cup as illustrated (A).

Turn the inhalation top clockwise until securely closed (B).

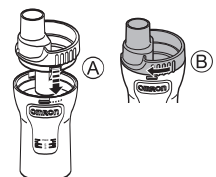

PREPARING THE NEBULIZER FOR USE

8. Attach the desired inhalation accessory.

NOTE: Mouthpiece and Nosepiece

Place the cap on the medication cup when using the mouthpiece or nosepiece. Using the cap with the mouthpiece or the nosepiece will reduce the amount of medication that is discharged into the air.

USING THE MOUTHPIECE

Place the cap on the medication cup over the inhalation air inlet (A).

Attach the mouthpiece (B).

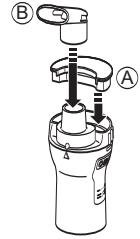

USING THE NOSEPIECE

Place the cap on the medication cup over the inhalation air inlet (A).

Attach the nosepiece (B).

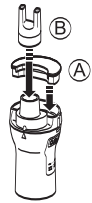

NOTE: Child Mask and Adult Mask

Do not place the cap on the medication cup when using the Child Mask or the Adult Mask.

USING THE CHILD MASK

Attach the mask to the inhalation top.

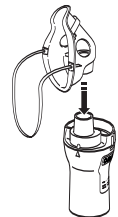

USING THE ADULT MASK

Attach the mask to the inhalation top.

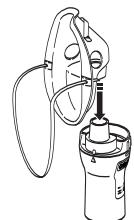

ATTACHING THE AIR TUBE

1. Push the Air Plug on one end of the Air Tube onto the Air Connector on the front side of the compressor (A).
2. Push the Air Plug on the other end of the Air Tube onto the Air Tube Connector on the bottom of the Nebulizer Kit (B).

NOTE: Keep the nebulizer kit upright when attaching the air tube. Medication may spill out of the medication cup.

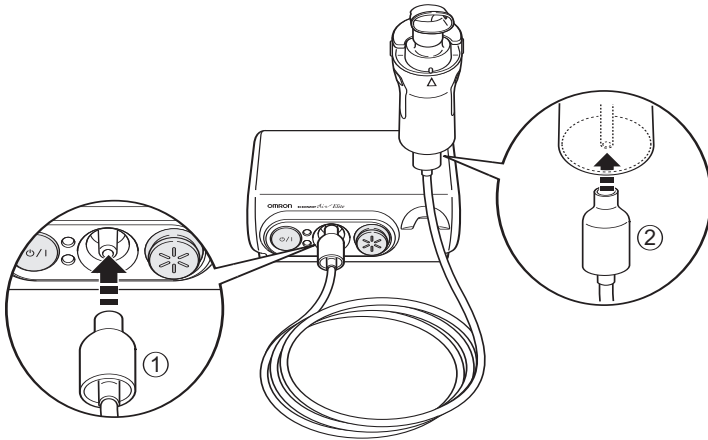

⚠ CAUTION

Make sure the nebulizer kit is correctly assembled, the air filter is properly installed, and the air tube is correctly connected to the compressor and the nebulizer kit. Air may leak from the air tube during use if not securely connected.

⚠ CAUTION

Do not use the device if the air tube is bent.

⚠ CAUTION

Make sure that the air tube is securely attached to the compressor (main unit) and nebulizing parts, and does not come loose. Twist the air tube slightly when inserting it into the connectors to avoid the tube disconnecting during use.

3. Use the Nebulizer Kit Holder as a temporary holder for the nebulizer kit.

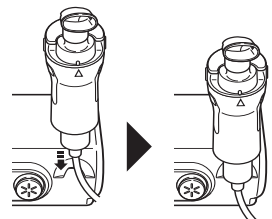

USING THE DEVICE

⚠ WARNING

Do not use the device where the device may be exposed to flammable gas or vapors.

⚠ WARNING

Do not use or store the device in humid locations, such as a bathroom. Use the device within the operating temperature and humidity.

⚠ CAUTION

Provide close supervision when this device is used by, on, or near infants, children or compromised individuals.

⚠ CAUTION

Do not use a cellular phone near the device. It may result in an operational failure.

⚠ CAUTION

Inspect the compressor (main unit) and the nebulizer parts each time before using the device. Make sure no parts are damaged, the nozzle and air tube are not blocked and the compressor operates normally.

1. Hold the nebulizer kit as illustrated on the right.

⚠ CAUTION

Do not tilt the nebulizer kit so the angle of the kit is greater than 45°. Medication may flow into the mouth.

⚠ CAUTION

Do not shake the nebulizer kit while using the device.

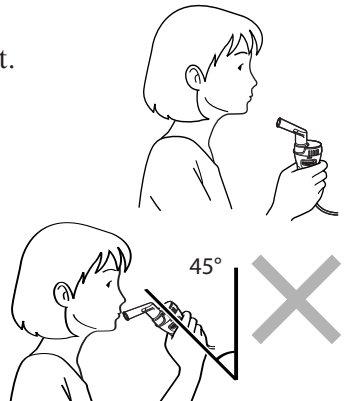

2. Turn the power switch on.

The compressor starts. Nebulization begins and aerosol is generated.

NOTE: The green light shows that the power is on.

⚠ CAUTION

Limit the use of the device to 20 minutes at a time, and wait 40 minutes before using the device again.

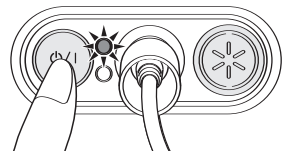

USING THE DEVICE

Press the power switch again to stop nebulization.

NOTE: The green light goes off.

⚠ WARNING

Do not cover the compressor with a blanket, towel, or any other type of cover during use. This could result in the compressor overheating or malfunctioning.

⚠ CAUTION

Do not block the air filter cover.

3. Inhale medication as instructed by your physician or licensed healthcare practitioner.

USING THE MOUTHPIECE

Insert the mouthpiece into your mouth. Inhale medication breathing normally. Exhale normally through the mouthpiece.

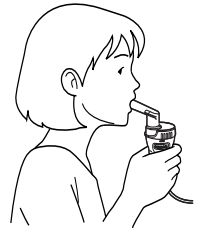

USING THE NOSEPIECE

Inhale the medication through the nosepiece as illustrated. Exhale through the mouth.



NOTE: Child Mask and Adult Mask

If the amount of aerosol is too much, place the cap on the medication cup over the inhalation air inlet.

USING THE CHILD MASK or THE ADULT MASK

Place the mask over the nose and mouth. Pull the elastic strap over the head. Gently pull on the strap to securely hold the mask over the nose and mouth. Inhale the medication. Exhale normally through the mask.



4. Complete the treatment.

⚠ WARNING

For type, dose, and regime of medication follow the instructions of your physician or licensed healthcare practitioner.

USING THE DEVICE

5. Press the power switch. The compressor turns off and nebulization stops.

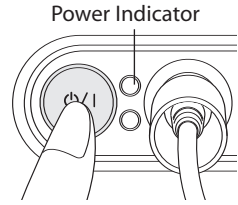

6. Disconnect the Air Tube from the Nebulizer Kit. Hold the Air Plug and gently pull down to disconnect the Air Plug from the Air Tube Connector on the bottom of the nebulizer kit.
7. Check the Air Tube. No condensation or moisture should remain in the Air Tube.

⚠ WARNING

Do not store the air tube with moisture or medication remaining in the air tube. This could result in infection as a result of bacteria.

If any condensation or moisture remains in the air tube, remove the moisture from the air tube. Follow the directions below:

1. Make sure the Air Tube is still connected to the Air Connector on the front side of the compressor.
 2. Press the power switch on. The compressor will start and pump air through the air tube to expel the moisture.
 3. Press the power switch again to turn the compressor off.
8. Disconnect the Air Tube from the compressor. Hold the Air Plug and gently pull the Air Plug off the Air Connector on the front side of the compressor.
 9. Unplug the device from the electrical outlet.

⚠ CAUTION

Unplug the power cord from the electrical outlet after using the device.

⚠ CAUTION

Remove the rechargeable battery and the AC Adaptor from the device after use.

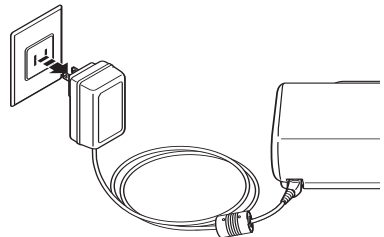

CLEANING AFTER EACH USE

Following the cleaning instructions after each use will prevent any remaining medication in the bottle from drying resulting in the device not nebulizing effectively and will help prevent infections.

⚠ WARNING

Wash the nebulizer parts after each use. Dry the parts immediately after washing.

1. Remove the inhalation accessory (mouthpiece, mask, or nosepiece) from the nebulizer kit.
2. Disconnect the air tubing from the nebulizer.
3. Gently twist the inhalation top counterclockwise and lift to separate the nebulizer into two sections.
4. Remove the baffle.
5. Discard remaining medication in the medication cup.

⚠ WARNING

Always dispose of any remaining medication in the medication cup after each use. Use fresh medication each time you use the device.

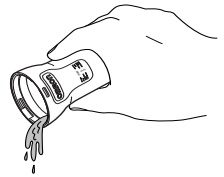

6. Rinse all the parts of the nebulizer kit and the mouthpiece or nosepiece with hot tap water. You may also wash these parts in a dishwasher. Remove the parts after the wash and rinse cycle is completed.

DO NOT wash the mask in a dishwasher.

⚠ CAUTION

Place the nebulizer pieces in a basket recommended for dishwasher use. Place the basket on the top shelf to avoid any damage to the nebulizer kit.

7. Rinse the mask with hot tap water.
8. Hand dry or air dry in a clean environment using a soft, clean, lint-free cloth.
9. Assemble the nebulizer and store the nebulizer kit in a dry, sealed bag.

⚠ CAUTION

The nebulizer kit should be replaced every 6 months.

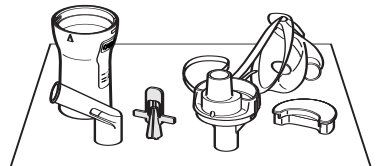

DAILY DISINFECTING

You can disinfect daily by soaking the parts in a vinegar solution or using a commercially available medical disinfectant. If your physician or respiratory therapist specifies a different cleaning procedure follow their instructions.

Disinfect the nebulizer kit and the mask, nosepiece or mouthpiece after the last treatment of the day.

VINEGAR METHOD

1. Make a solution of 1 part white vinegar and 3 parts distilled water. Make enough solution to submerge the parts.
2. Remove the inhalation accessory (mouthpiece, mask, or nosepiece) from the nebulizer kit.
3. Disconnect the air tubing from the nebulizer.
4. Gently twist the inhalation top counterclockwise and lift to separate the nebulizer into two sections.
5. Remove the baffle.
6. Wash all the parts of the nebulizer kit, the mouthpiece, nosepiece or mask in warm water and a mild detergent. Rinse in hot tap water. You may also wash the nebulizer kit, mouthpiece or nosepiece in a dishwasher. **DO NOT** wash the mask in a dishwasher.

⚠ CAUTION

Place the nebulizer pieces in a basket recommended for dishwasher use. Place the basket on the top shelf to avoid any damage to the nebulizer kit.

DAILY DISINFECTING

7. Submerge the parts in the white vinegar and distilled water solution for 30 minutes.
8. Remove the parts and discard the solution. Rinse the parts with hot tap water.
9. Hand dry or air dry in a clean environment using a soft, clean, lint-free cloth.
10. Assemble the nebulizer and store the nebulizer kit in a dry, sealed bag.



WARNING

Store the device and the components in a clean, safe location.

MEDICAL DISINFECTANT METHOD

Consult your physician or respiratory therapist regarding the use of medical disinfectant cleaners. Carefully follow the instructions supplied by the manufacturer of the medical disinfectant.

CHANGING THE AIR FILTER

Change the air filter every 60 days even if the air filter does not appear dirty. If the air filter appears dirty, or if water or medication has spilled on the air filter, replace with a new air filter immediately.

1. Pull the air filter cover to remove from the front side of the compressor.

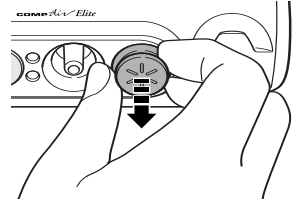

2. Remove the dirty filter with a small pointed object.

⚠ CAUTION

Do not attempt to wash or clean the air filter. Damp air filters can cause blockages. Do not substitute cotton or any other material for the air filter.

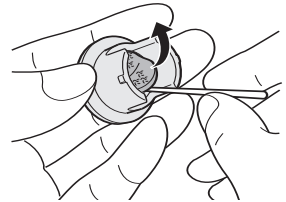

⚠ CAUTION

Wash the air filter cover regularly to prevent any blockage in the cover. Do not boil. Make sure the cover is dry before inserting the new air filter.

3. Insert a new air filter into the air filter cover.

⚠ CAUTION

Before inserting the new air filter make sure the air filter is clean and free of dust. Do not operate the device without the air filter. Use only the Omron air filter designed for this device.

4. Put the air filter cover back on the compressor.

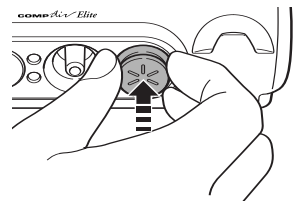

CARING FOR THE DEVICE

To keep your device in the best condition and protect the unit from damage follow these directions:

⚠ CAUTION

Do not subject the compressor, rechargeable battery, battery charger or any of the components to strong shocks, such as dropping on the floor.

⚠ CAUTION

Use only Omron authorized parts and accessories. Parts and accessories not approved for use with the device may damage the unit.

CLEANING THE COMPRESSOR

Clean the casing of the main unit by using a soft cloth moistened with water or a mild detergent. Do not use abrasive cleaners. Dry the casing immediately using a soft clean cloth.

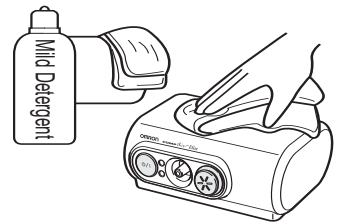

⚠ WARNING

Do not immerse the compressor (main unit) in water or other liquid.

⚠ CAUTION

Unplug the power cord from the electrical outlet before cleaning the device.

⚠ CAUTION

Do not insert any object into the compressor.

CARING FOR THE DEVICE

STORING THE DEVICE

1. Put the nebulizer kit and the inhalation accessory (mouthpiece, nosepiece or mask) in a dry, sealed bag. Place the bag in the storage pocket of the carrying bag.
2. Coil the air tubing and place in the storage pocket.
3. Place the compressor in the carrying bag.

⚠ CAUTION

Do not wrap the power cord around the compressor (main unit).

4. Zipper the bag closed.
5. Store the device in a safe, clean location. Do not store the device in extreme hot or cold temperature, high humidity or in direct sunlight.

⚠ WARNING

Do not leave the device or its parts where it will be exposed to extreme temperatures or changes in humidity, such as leaving the device in a vehicle during warm or hot months, or where it will be exposed to direct sunlight.

⚠ WARNING

Keep the device out of the reach of unsupervised infants and children. The device may contain small parts that can be swallowed.

⚠ CAUTION

Do not carry or leave the nebulizer with medication in the medication cup.

AUTHORIZED SERVICE

Contact Omron Healthcare customer service for warranty and repair services. There are no user serviceable parts. Unauthorized service will void the user warranty.

⚠ CAUTION

Do not disassemble or attempt to repair the device or components.

TROUBLESHOOTING GUIDE

PROBLEM	CAUSE	SOLUTION
No power on unit when the power switch is on.	<p>The AC power cord is not plugged into an electrical outlet.</p> <p>The rechargeable battery is not connected correctly, not sufficiently charged, or the battery has expired.</p>	<p>Turn the power switch off.</p> <p>Plug the power plug into an electrical outlet. Turn the device on. Make sure the battery is correctly connected to the compressor. Charge the battery. Replace the battery with a new one.</p>
No nebulization or low nebulization rate when the power is on.	<p>No medication in the medication cup.</p> <p>Too much or too little medication in the medication cup.</p>	<p>Add the correct amount of prescribed medication to the medication cup.</p>
	<p>The baffle is not placed in the medication cup or incorrectly positioned.</p>	<p>Make sure the baffle is correctly positioned over the nozzle in the medication cup.</p>
	<p>The nebulizer kit is not correctly assembled.</p>	<p>Make sure the nebulizer kit is correctly assembled and the inhalation accessory is correctly attached.</p>
	<p>The nozzle is blocked.</p>	<p>Clean and disinfect the nebulizer kit to remove the blockage.</p>
	<p>The nebulizer kit is tilted at an incorrect angle.</p>	<p>Hold the nebulizer kit correctly. Do not tilt the nebulizer kit so the angle of the kit is greater than 45 degrees.</p>
	<p>The air tube is incorrectly attached.</p>	<p>Make sure the air tube is correctly attached to the compressor and the nebulizer kit.</p>
	<p>The air tube is folded or damaged.</p> <p>The air tube is blocked.</p>	<p>Make sure the air tube is not folded, kinked or bent. Inspect the air tube for any damage. Replace the air tube if damaged.</p>
	<p>The air filter is dirty.</p>	<p>Replace the air filter with a new clean air filter.</p>
The device is abnormally loud.	<p>The air filter cover is incorrectly attached.</p>	<p>Attach the air filter cover correctly. Make sure the air filter cover is not blocked.</p>
The device is very hot.	<p>The compressor is covered.</p> <p>The device has been used for longer than 20 minutes.</p>	<p>Do not cover the compressor with any type of cover during use. Turn the device off. Wait 40 minutes before using the device again.</p>

WARRANTY

LIMITED WARRANTIES

Your Omron NE-C30 CompAir® Elite Nebulizer Compressor, excluding the nebulizer kit, inhalation accessories, air tube and air filters, is warranted to be free from defects in materials and workmanship appearing within 5 years from the date of purchase, when used in accordance with the instructions provided with your device. The above warranty extends only to the original retail purchaser.

We will, at our option, repair or replace without charge your Omron Nebulizer Compressor. Repair or replacement is our only responsibility and your only remedy under the above warranties.

To obtain warranty service contact Omron Healthcare's Customer Service by calling **1-800-634-4350** for the address of the repair location and the return shipping and handling fee. Information for warranty service is available on our website at www.omronhealthcare.com.

Enclose the Proof of Purchase. Include a letter, with your name, address, phone number, and description of the specific problem. Pack the product carefully to prevent damage in transit. Because of possible loss in transit, we recommend insuring the product with return receipt requested.

ALL IMPLIED WARRANTIES, INCLUDING BUT NOT LIMITED TO THE IMPLIED WARRANTIES OF MERCHANTABILITY AND FITNESS FOR PARTICULAR PURPOSE, ARE LIMITED TO THE DURATION OF THE APPLICABLE WRITTEN WARRANTY ABOVE. Some states do not allow limitations on how long an implied warranty lasts, so the above limitation may not apply to you.

OMRON SHALL NOT BE LIABLE FOR LOSS OF USE OR ANY OTHER INCIDENTAL, CONSEQUENTIAL OR INDIRECT COSTS, EXPENSES OR DAMAGES. Some states do not allow the exclusion or limitation of incidental or consequential damages, so the above exclusions may not apply to you.

This warranty gives you specific legal rights, and you may also have other rights which may vary from state to state.

FOR CUSTOMER SERVICE (USA and Canada)

Visit our web site at: www.omronhealthcare.com

Call toll free: 1-800-634-4350

LIMITED WARRANTIES (OUTSIDE OF THE USA AND CANADA)

Your Omron NE-C30 CompAir® Elite Nebulizer Compressor, excluding the nebulizer kit, inhalation accessories, air tube and air filters, is warranted to be free from defects in materials and workmanship appearing within 5 years from the date of purchase, when used in accordance with the instructions provided with your device. The above warranty extends only to the original retail purchaser. Should repair be needed during the warranty period, please contact the authorized distributor in your country.

The above warranty is complete and exclusive. The warrantor expressly disclaims liability for incidental, special, or consequential damages of any nature. (Some countries do not allow the exclusion or limitation of incidental or consequential damages, so the above warranty may not apply to you).

Any implied warranties arising by the operation of law shall be limited in duration to the term of this warranty. (Some countries do not allow limitations on how long an implied warranty lasts, so the above limitation may not apply to you).

This warranty gives you specific legal rights and you may have other rights which vary from country to country.

FCC STATEMENT

Note:

POTENTIAL FOR RADIO/TELEVISION INTERFERENCE (for U.S.A. only)

This product has been tested and found to comply with the limits for a Class B digital device, pursuant to part 15 of the FCC rules.

These limits are designed to provide reasonable protection against harmful interference in a residential installation. The product generates, uses, and can radiate radio frequency energy and, if not installed and used in accordance with the instructions, may cause harmful interference to radio communications. However, there is no guarantee that interference will not occur in a particular installation. If the product does cause harmful interference to radio or television reception, which can be determined by turning the product on and off, the user is encouraged to try to correct the interference by one or more of the following measures:

- Reorient or relocate the receiving antenna.
- Increase the separation between the product and the receiver.
- Connect the product into an outlet on a circuit different from that to which the receiver is connected.
- Consult the dealer or an experienced radio/TV technician for help.

POTENTIAL FOR RADIO/TELEVISION INTERFERENCE (for Canada only)

This digital apparatus does not exceed the Class B limits for radio noise emissions from digital apparatus as set out in the interference-causing equipment standard entitled “Digital Apparatus”, ICES-003 of the Canadian Department of Communications.

Cet appareil numérique respecte les limites de bruits radioélectriques applicables aux appareils numériques de Classe B prescrites dans la norme sur le matériel brouilleur: “Appareils Numériques”, ICES-003 édictée par le ministre des communications.

Changes or modifications not expressly approved by the party responsible for compliance could void the user's authority to operate the equipment.

SPECIFICATIONS

Model:	NE-C30
Type:	Compressor nebulizer
Power Supply:	12VDC 1A (Compressor) 100V-240VAC 50-60Hz (AC adapter)
Power Consumption:	12 watts
Nebulizer Rate:	0.35 ml/min (without cap)
Particle Size:	*MMD approximately 5 μ m (based on EN13544-1)
Medication Cup Capacity:	7 ml (cc) max.
Appropriate Medication Quantities:	2 mL - 7 mL (cc)
Operating Temperature/ Humidity:	+50°F to +104°F (+10°C to +40°C), 30% to 85% RH
Storage Temperature/ Humidity/Air Pressure:	-4°F to +140°F (-20°C to +60°C), 10% to 95% RH 700hPa to 1060 hPa
Weight:	Approx. 15.5 oz. (440g) (compressor only)
Dimensions:	Approx. 4 7/8" (w) \times 2" (h) \times 4 1/8" (d) (124 mm \times 52mm \times 103mm)
Contents:	Compressor, Nebulizer Kit, Air Tube, Air Filter Cover, Mouthpiece, 5 Replacement Filters, Child Mask, AC Adapter, Carrying Bag, Instruction Manual printed in English, Spanish and Portuguese, Instructional DVD, and User Registration Card.
UPC Code:	0 73796 45330 5

*MMD = Mass Median Diameter
Tested using malvern laser

NOTES:

- Subject to technical modification without prior notice.
- Please note that specifications may vary with medication type used.
- Do not use the device where it may be exposed to flammable gas.
- This unit conforms to EMC Standard IEC60601-1-2:2001. However, if it is used together with other medical devices or electrical equipment, they may influence the operations of one of devices. Please follow any instructions in the manuals and use all devices correctly.

 = Type B  = Class II



COMPRESSOR NEBULIZER

With respect to electric shock, fire and mechanical hazards in accordance with UL60601-1

NOTES

Manufactured By Omron

Made in Japan

Distributed by:

Omron Healthcare, Inc.

1200 Lakeside Drive

Bannockburn, Illinois 60015

www.omronhealthcare.com

Copyright © 2006 OMRON HEALTHCARE, INC.

C30 INST Rev

1657680-2A