



READ AND SAVE THESE INSTRUCTIONS

Evaporative Vortex Humidifier Owner's Guide

LEER Y GUARDAR ESTAS INSTRUCCIONES

Guía Del Propietario Del Humidificador Evaporativo Tipo Vórtice

LISEZ ET CONSERVEZ CES INSTRUCTIONS

Mode D'emploi Humidificateur D'air Par Évaporation Vortex

www.vornado.com

models: EVAP1 and EVAP3

Designed, engineered and supported in Andover, Kansas.

Pensado, diseñado y respaldado en Andover, Kansas.

Conception, mise au point et soutien technique effectués à Andover, au Kansas.

Questions or comments?
¿Preguntas o comentarios?
Questions ou commentaires?



www.vornado.com



consumerservice@vornado.com



800.234.0604

Important Instructions	4
The Vornado Difference	6
Product Information.....	7
Controls.....	8
Getting Started	9
How To Use	10
Cleaning and Maintenance	11
Filter Replacement.....	13
Operating Tips	14
Automatic Refill Program.....	14
Troubleshooting	15
Warranty.....	16

IMPORTANT INSTRUCTIONS

READ ALL INSTRUCTIONS BEFORE USING.

When using electrical appliances, basic precautions should always be followed to reduce the risk of fire, electrical shock and injury to persons, including the following:

- **Do** read all instructions before using this Humidifier.
- **Do** turn the Humidifier off if the relative humidity exceeds 60%. Humidity levels above 60% may allow moisture to build up indoors and condense on surfaces, where microorganisms can settle and grow. For accurate humidity readings, use a hygrometer which is available at most hardware stores and home centers.
- **Do** unplug the Humidifier prior to moving, cleaning or refilling.
- **Do** unplug and empty this Humidifier when not in operation.
- **Do** empty water from the unit if the Humidifier is to be turned off and left for more than 8 hours, as leaving the water will encourage the growth of microorganisms. If this happens, thoroughly clean and disinfect the unit. (Refer to the CLEANING AND MAINTENANCE.)
- **Do** remove the Water Tank first if you need to move the Humidifier to another location.
- This Humidifier requires periodic cleaning. Refer to the CLEANING AND MAINTENANCE instructions provided. **Do Not** clean the Humidifier in any manner other than as instructed in this manual.
- **Do Not** use this Humidifier on an uneven surface. Always place this Humidifier on a firm, flat surface.
- **Do Not** defeat the safety purpose of the polarized plug. This product is equipped with a polarized alternating current line plug (a plug having one blade wider than the other). This plug will fit into the power outlet only one way. This is a SAFETY FEATURE. If you are unable to insert the plug fully into the outlet, try reversing the plug. If the plug still fails to fit, contact an electrician to replace the obsolete outlet.
- **Do Not** operate the Humidifier with a damaged cord or plug, after the Humidifier malfunctions, or has been dropped or damaged in any manner. Return to Vornado for examination, electrical or mechanical adjustment or repair.
- **Do Not** run power cord under carpeting.
- **Do Not** cover cord with throw rugs, runners or similar objects. Arrange the power cord away from traffic areas, so it will not become a tripping hazard.
- **Do Not** place the Humidifier near heat sources such as stoves, radiators or heaters.
- **Do Not** pour water through the top Outlet Air Grill on the Power Head.
- **Do Not** use undiluted bleach or ammonia, strong detergents, abrasive cleansers, gasoline, paint thinner or other solvents to clean this Humidifier. Use only water and mild detergents to perform daily maintenance on your Humidifier.
- **DO NOT ATTEMPT TO DISASSEMBLE THE POWER HEAD.** DOING SO WILL VOID YOUR WARRANTY AND COULD CAUSE DAMAGE AND/OR PERSONAL INJURY. The Power Head contains no user serviceable parts. If you experience a problem, please see the limited warranty for information.
- **Do Not** repeatedly remove and replace the Water Tank. This will only fill the Base and water will spill out.
- Humidifiers should be kept away from children and not be placed in a child's room without supervision.

IMPORTANT INSTRUCTIONS

READ ALL INSTRUCTIONS BEFORE USING.

- **Do** use common sense when using this product and/or any electrical appliance. This appliance is not intended for use by persons (including children) with a reduced physical, sensory or mental capabilities, or lack of experience and knowledge, unless they have been given supervision or instruction concerning use of the appliance by a person responsible for their safety. Children should be supervised to ensure that they do not play with the appliance.

Note: This equipment has been tested and found to comply with the limits for Class B digital device, pursuant to part 15 of the FCC Rules. These limits are designed to provide reasonable protection against harmful interference in a residential installation. This equipment generates, uses and can radiate radio frequency energy and, if not installed and used in accordance with the instructions, may cause harmful interference to radio or television reception, which can be determined by turning the equipment off and on, the user is encouraged to try to correct the interference by one or more of the following measures:

- Reorient or relocate the receiving antenna.
- Increase the separation between the equipment and the receiver.
- Connect the equipment into an outlet on a circuit different from that to which the receiver is connected.
- Consult the dealer or an experienced radio/TV technician for help.

This device complies with part 15 of the FCC Rules. Operation is subject to the following two conditions: (1) This device may not cause harmful interference, and (2) his device must accept any interference received, including interference that may cause undesired operation.

This Class B digital apparatus complies with Canadian ICES-003.

Trust.

It is said that trust isn't given, but earned. For decades Vornado has been earning the trust of our customers by offering them only the best. Vornado provides the highest level of performance, coupled with the highest level of support available. Complete satisfaction with no exceptions – this is Vornado's promise to you. If you are not satisfied for any reason, please contact us. Knowledgeable representatives are available at 1-800-234-0604 from 7:00 AM to 6:00 PM CST. A wealth of additional support is also available online at www.vornado.com. On behalf of myself and the entire staff at our Andover, Kansas headquarters – thank you for selecting Vornado.

Sincerely,
Bill Phillips
CEO, Vornado Air



Find our complete product line at www.vornado.com

The Vornado Difference

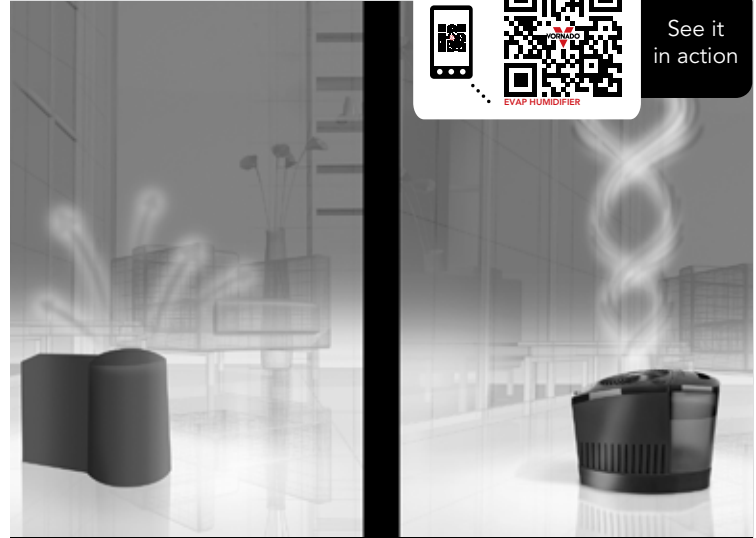

Without Adequate Circulation

With Vornado Vortex Action

The Vornado Vortex assisted humidifier distributes moisture farther into the room, enabling faster humidification. By incorporating Vornado's exclusive Vortex Action, the humidifier moves large volumes of harsh, dry air through two specially designed filters and circulates the moistened air throughout the room, providing complete and even humidification.

Product Information

Vornado® Evap1 & Evap3 Humidifier Parts

While your Vornado® Evaporative Humidifier requires no assembly, you will need to know how to remove the Water Tank and Filter for cleaning, maintenance, and filter replacement. The components are as follows:

Control Panel

Easily adjust Fan Settings and set Humidity level: 35% - 60% or Continuous.

Power Head

Powerful motor circulates moist air throughout the whole room.

2 Vornado Evaporative Filters

Wick up water.

Inlet Grills

Designed for efficient air intake.

Base

Durable, leak-resistant construction.

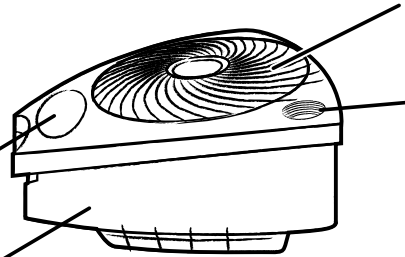

Air Outlet Grill

Initiates Vornado's signature Vortex circulation.

Humidistat

Reads humidity in the room for automatic humidity control.

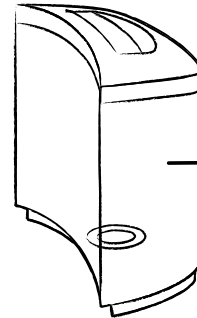

Water Tank

Large 1.5 gallon capacity allows for fewer refills.

Gasket

Creates a waterproof seal between Cap and Water Tank.

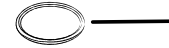

Cap

Easy-to-remove Cap for convenient Water Tank refilling.



Fill Port

Releases water from Water Tank into Base.

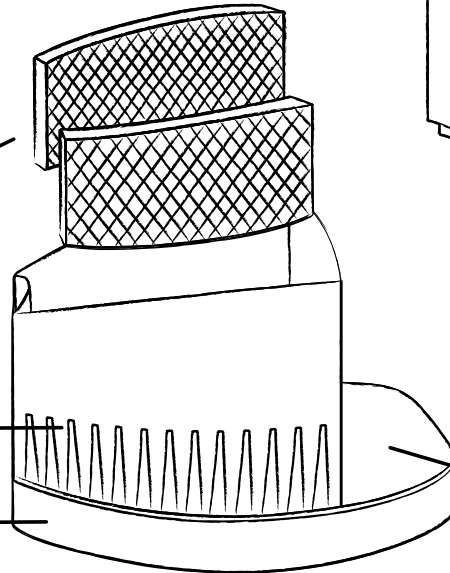

Controls

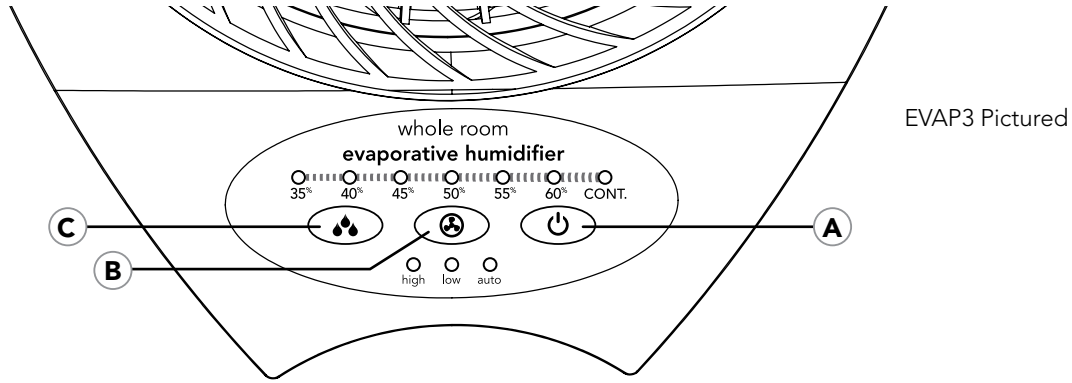

- A Power Button** - turns the unit On or Off. LED indicator lights will illuminate default settings when powered On. Unit will default to High Fan Speed, Continuous Humidity.
- B Fan Setting Button** - select desired Fan Setting. On the EVAP3 select - Low, High or Auto. On the EVAP1 select - Low (I), Medium (II) or High (III).
Low or (I) - operation for quiet, nighttime use or smaller rooms. On Low operation, your Humidifier may run without refilling for extended periods.
Medium or (II), EVAP1 Only - operation for normal use.
High or (III) - operation for fast humidification for larger rooms. High speed operation will evaporate 2.6 gallons of water (+/- 10%) in 24 hours of continuous operation. (This assumes room conditions of 70° F and 30% relative humidity.)

Auto, EVAP3 Only - operation for more precise humidity control. Fan speed will fluctuate between High, Low and Off to better maintain set humidity level with the minimal amount of Fan noise.

- C Humidity Button** - sets desired humidity level. Press Humidity Button until desired humidification level is illuminated, 35% - 60% or Continuous. The unit will operate until the desired humidity level is reached, at this point, the Fan will turn Off and the Fan speed indicator light will turn Off. The Humidity level indicator light will remain On. If the Fan does not turn on, the set Humidity level may be lower than the room humidity level. Increase the Humidity set point until the Fan turns On. This is an indication of the level of humidity already in the room. If moisture forms on walls or windows, lower humidity settings or turn Off Humidifier.

A Humidifier is quite useful in supplying necessary moisture to dry air. It should be used with proper care to prevent over-humidification. A good rule of thumb would be to gauge the condensation or frost on windows. Adjust your Humidifier to a point where this condition is at a minimum. These adjustments should be made when major changes in outdoor temperatures occur. Humidifiers can be placed in any living area that has a location that is convenient and provides distribution of the moist air to the living area.

The measured output of a Humidifier is based upon continuous operation at standard rating conditions. With normal variations of indoor and outdoor conditions, the Humidistat controlled Humidifier will not run continuously, at maximum output, unless the controls are set to do so.

Initial Humidity requirements:

When initially installed or when placed in operation at the beginning of each season, the Humidifier equipped with a Humidistat may run constantly for a day or so and thus evaporate large quantities of moisture. When the home and its furnishings have absorbed moisture and become stabilized at the desired humidity level, the amount of water used will diminish and the Humidifier operation will maintain the desired humidity level.

Before Operating

DO NOT lift the Humidifier out of the carton by the recessed handle on the Water Tank. This will cause the Water Tank to detach from the unit and might cause the Humidifier to drop and become damaged. Reach under the Humidifier, and lift from the bottom of unit.

Your new Humidifier uses a sizable volume of water, so we recommend checking the Base and Water Tank for leaks that may have occurred due to damage caused in shipping.

Note: A visual inspection may not reveal hairline fractures.

To Check For Leaks:

1. Place Humidifier on a water-resistant surface.
2. Remove the Water Tank and fill with water to inspect for leaks.
3. Next, pour several cups of water into the Base to inspect for leaks.

Not Leaking?

Empty water from Base and install the full Water Tank.

Leaking?

In the slight chance your Humidifier has leaks, contact Consumer Services and we will immediately replace damaged parts.

How To Use

Installing Water Tank

This Humidifier has a 1.5 gallon capacity and 2.6 gallon output in 24 hours (if set to High Fan Speed, Continuous Humidity setting).

1. Unplug Humidifier. Place on firm and level surface, such as the floor.

Note: Spills can occur during cleaning, moving, or refilling Water Tank, so be careful to avoid spills when doing these activities.

2. Remove the Water Tank by grasping the recessed handle and pulling towards you (A).
3. Turn Water Tank upside down and Remove Cap (B).

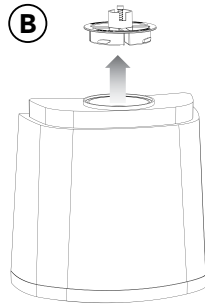
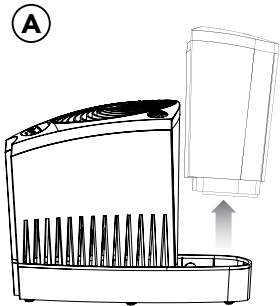

4. Empty any remaining water inside Water Tank. Rinse, wipe clean and dry with clean cloth or paper towel.

5. Place Water Tank in sink with opening at the top and fill Water Tank with cool tap water.

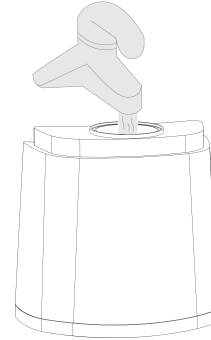

6. Ensure Gasket, the rubber ring around the Cap, is properly positioned and replace Cap. Some downward pressure may be needed to compress the Gasket prior to rotating the Cap 1/4 turn clockwise.
7. Lower Water Tank into Base, positioning Fill Port (C) over raised bump in Base (D). Once in nested position, the water outlet valve inside Cap will open, releasing water into Base.

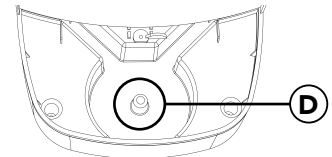
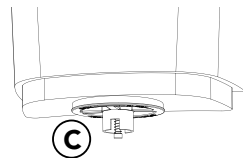

How To Use

Operation

1. Position the unit to not blow directly on objects or plants. Plug the unit into a 110-120 volt AC outlet.
2. To turn unit On, press the Power button. The indicator lights will turn on in the default setting HIGH Fan speed and Continuous Humidity (initial plug-in only).

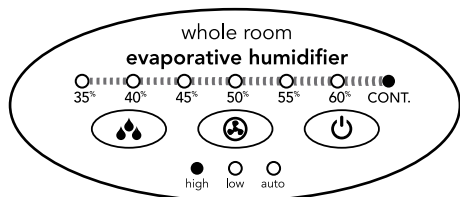

3. Adjust settings for desired operation. The humidifier will store your settings during normal On/Off cycles. If the unit becomes unplugged, it will default to the factory setting - High Fan speed and Continuous Humidity.

Refilling Water Tank

1. Empty Water Tank before refilling with clean water. Rinse, wipe clean and dry with clean cloth or paper towel.
2. Refill Water Tank with cool, clean tap water. Do not overfill.
3. Lower humidity control settings or turn Off Humidifier if moisture forms on walls or windows.

Cleaning and Maintenance

Proper cleaning of your Evaporative Vortex Humidifier is essential to the air quality and performance of your unit. The frequency in which your Humidifier will need to be cleaned will vary, depending on use, water hardness, and outside environmental factors. It is recommended, assuming average use, to thoroughly clean the unit several times throughout the season, or when algae, mineral deposits or other particles begin to form.

1. Turn the Humidifier Off and unplug. Do not submerge in water.
2. Remove Power Head and Filters.
3. Remove Water Tank and Inlet Grill. To remove Inlet Grill, undo the latch (E) and lift Inlet Grill up (F).

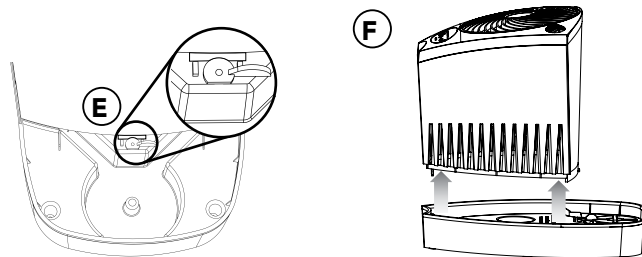

4. Empty the Base and Water Tank, then rinse with clean tap water. As noted, depending on the quality of water in your home, impurities can build up quickly or may take some time. It is possible that some scale may form on the inside of the Base.

Cleaning and Maintenance

To Clean Base

1. Mix a solution of one (1) 8 oz. cup of undiluted white vinegar and 1 gallon of water. Fill the Base with the solution; discard any remaining solution. Let solution stay for 20 minutes.



2. Empty after 20 minutes and clean all interior surfaces with soft brush. Dampen a soft cloth with undiluted white vinegar and wipe out Base to remove scale.
3. Rinse thoroughly with clean warm water to remove scale and cleaning solution before disinfecting the Base.

Disinfecting The Base

1. Mix a solution of 1 teaspoon chlorine bleach and 1 gallon of water. Fill the Base with the solution, discard any remaining solution. Let solution stay 20 minutes. Wet all surfaces.



2. Empty Base after 20 minutes. Rinse with water until bleach smell is gone. Dry with clean cloth or paper towel.
3. We recommend replacing the Filter after use, but to prolong the life of the Filter, disinfect by washing it in a solution of one teaspoon of chlorine bleach in one gallon of water. Rinse thoroughly to get rid of the bleach odor.
4. Reinstall all components. Components must be securely in place for unit to function properly.

End Of Season Maintenance

1. Follow instructions at end of humidification season or when Humidifier will not be used for at least one week or more.
2. Let Humidifier dry completely before storing. Do not store with water inside Water Tank or Base.
3. Remove and discard the Filters if it is not suitable for reuse. Do not store the Humidifier with wet Filters. If Filters are suitable for future use, remove and empty water from the Base and Water Tank. Replace the Water Tank, power unit On and select the HIGH Fan Speed. Allow the unit to run until the Filters are completely dry.
3. Store in cool, dry location.

Filter Replacement

The Filters may accumulate minerals and other impurities that occur naturally in any water supply. While your Humidifier came equipped with two Filters, you will eventually have to replace them, as they last approximately 4-8 weeks, depending on use. You will know the Filter needs to be replaced when it becomes hard and is no longer absorbing the water effectively. Replace the Filter with only a genuine Vornado® brand Filter. While other brands may fit our units, these filters do not carry the same quality and life as our own and can diminish the Humidifier's performance.



View filter replacement tutorial on your mobile device.

Replacing The Filter

1. Turn the unit Off and unplug.
2. Remove Power Head.

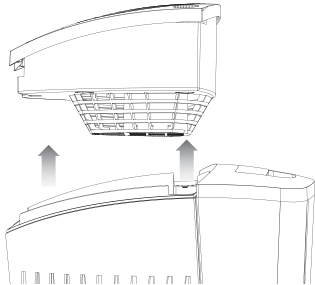

3. Remove and discard used Filters.
4. Install new genuine Vornado Filters by making sure they are flush against the sides of the unit and touching the bottom of the Base.

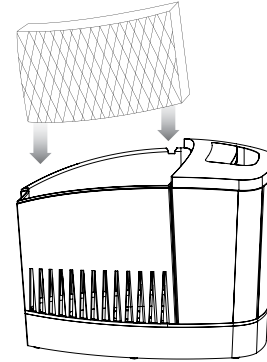

5. Replace Power Head. Your Humidifier is now ready for use.

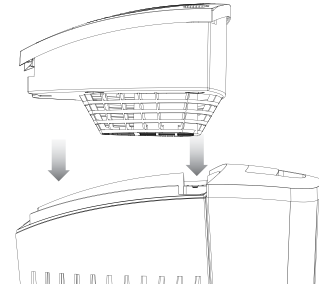

Operating Tips

There are several things to be aware of as your Vornado® Evaporative Humidifier is operating:

- If you operate your Humidifier continuously, it may need to be refilled with water every day. Simply look through the Water Tank to be certain that there is adequate water supply for operation.
- Protect the Water Tank from damage. Any cracks or damage to the Tank may cause it to leak water onto the floor or other surfaces.
- On first use, the Filters may give off a mild odor. The odor is not harmful and will go away after the first few hours of operation. If the odor is exceptionally strong, you can help eliminate most or all of it by soaking the Filters for 20 to 30 minutes in a solution of 1 gallon water to 2 teaspoons white vinegar. Rinse thoroughly.
- If the Humidifier is turned Off, with water in the unit, and not turned back on for 8 hours or longer, or if the unit is not cleaned as recommended, you may experience some growth of algae or bacteria. These microorganisms may become airborne. Thoroughly clean the unit to eliminate any microorganisms.
- Allow for optimum airflow by keeping the grill unobstructed. Ensure curtains and other items are far enough away from the unit to not be pulled into the side inlets or interfere with airflow.
- We recommend you operate your Humidifier continuously. This helps maintain humidity all day long, costs only pennies a day, and will not harm the unit.

Extending Filter Life

Many factors affect the life of the Filters - including amount of use, water hardness, and outside environmental factors. Below are tips to help extend the life of your Filter:

1. The additional sodium in chemically softened water may cause Filters to harden or become mushy. Try using untreated or tap water.
2. Hard water or water with excessive minerals such as lime or iron may shorten Filter life. Try Bacteriostat or Water Treatment found at most hardware or home specialty stores. Or periodically remove the Filters and clean, by soaking them in cool tap water (enough to cover the Filters) and two teaspoons of white vinegar. Let stand 20 minutes, then rinse in cool water. Allow excess water to run off and dry before replacing them in the Base. **DO NOT** wring.
3. Leaving the Filters too long in a filled Humidifier without the fan running may cause mold, mildew, and deterioration. If Humidifier is filled, do not leave it off for more than eight hours.

Automatic Refill Program

Select the shipment interval and Vornado will send replacement Filters automatically. Eliminate the hassle of remembering to reorder. Maintain the high efficiency of your Vornado Humidifier. **To sign up**, visit www.vornado.com, email consumerservice@vornado.com or call 1-800-234-0604. Cancel at anytime.



Part # **MD1-0002**

Troubleshooting

Problem	Possible Cause and Solution
Unit fails to power on.	Unit is not plugged in. Plug power cord into electrical outlet.
	Household circuit breaker / ground fault interrupter has tripped or blown a fuse. Reset circuit breaker / ground fault interrupter, or replace fuse. For assistance, contact a licensed electrician.
	Unit is damaged or in need of repair. Cease usage and unplug. Contact Consumer Service for assistance.
Unit makes a bubbling or gurgling sound.	This is normal. Water is being dispensed into Base.
Unit is not producing desired amount of humidity.	Water level in Tank is empty or too low. Refill with clean, cool tap water. (See HOW TO USE for instructions.)
	Unit has reached its set point. When set humidity level is reached, the Fan will turn off until humidity level in the room drops below humidity set point.
	Airflow is blocked. Remove obstruction.
	Unit settings are too low. Set to High Fan Speed and Continuous Humidity for maximum humidity output.
Filters are in need of replacement too often.	The additional sodium in chemically softened water may cause Filters to harden or become mushy. Try using untreated tap water or distilled water.
	Try adding Bacteriostat or Water Treatment found at most hardware or home specialty stores to the water. Or periodically remove the Filters and clean, by soaking them in cool tap water and two teaspoons of white vinegar. Let stand 20 minutes, then rinse in cool water. Allow excess water to run off and dry before replacing them in the Base. DO NOT wring.

Warranty



Evaporative Vortex Humidifier • 5 Year Limited Warranty

Vornado Air LLC (“Vornado”) warrants to the original consumer or purchaser this Vornado® Evaporative Vortex Humidifier (“Product”) is free from defects in material or workmanship for a period of five (5) years from the date of purchase, depending on model. If any such defect is discovered within the warranty period, Vornado, at its discretion, will repair or replace the Product at no cost. Repairs not covered by the warranty or outside the warranty period will require a fee to cover the cost of materials, labor, handling and shipping.

This warranty does not apply to defects resulting from abuse of the Product, modification, alteration, repair or service of the Product by anyone other than Vornado, mishandling, improper maintenance, commercial use of the Product, damages which occur in shipment or are attributed to acts of God.

REPAIR OR REPLACEMENT AS PROVIDED UNDER THIS WARRANTY IS THE EXCLUSIVE REMEDY OF THE CONSUMER. VORNADO SHALL NOT BE LIABLE FOR ANY INCIDENTAL OR CONSEQUENTIAL DAMAGES FOR BREACH OF ANY EXPRESS OR IMPLIED WARRANTY ON THIS PRODUCT. EXCEPT TO THE EXTENT PROHIBITED BY APPLICABLE LAW, ANY IMPLIED WARRANTY OF MERCHANTABILITY OR FITNESS FOR A PARTICULAR PURPOSE ON THIS PRODUCT IS LIMITED IN DURATION TO THE DURATION OF THIS WARRANTY.

Some states do not allow the exclusion or limitation of incidental or consequential damages, or allow limitations on how long an implied warranty lasts, so the above limitations or exclusions may not apply to you. This warranty gives you specific legal rights, and you may have other rights that vary from state to state.

For warranty or repair service, call 1-800-234-0604 or email consumerservice@vornado.com to obtain a Return Authorization (“RA”) form. Please have or include your Product’s model number and serial number, as well as your name, address, city, state, zip code and phone number when contacting Vornado for warranty service. After receiving the RA form, ship your Product to:

Vornado Air LLC
Attn: Warranty & Repair
415 East 13th Street
Andover, KS 67002

For your convenience, please have your model number and serial number when contacting Vornado with service inquiries. To assure proper handling, packages must be clearly marked with the RA number. Packages not clearly marked with the RA number may be refused at the receiving dock. Please allow 1-2 weeks for repair and return of your Product after the Product is received. For your records: Staple or attach your original sales receipt to this Owner’s Guide. Please also write your product’s serial number below (located on product specs decal).

Serial No. _____

Product registration available online at www.vornado.com
© 2012 Vornado Air LLC Andover, KS 67002
Patents Pending. Specifications subject to change without notice.
Vornado® is a trademark owned by Vornado Air LLC.
Designed and Engineered in the U.S.A. Manufactured in China.
www.vornado.com consumerservice@vornado.com 800.234.0604



Vornado Air, LLC
415 East 13th Street, Andover, Kansas 67002
800.234.0604 | www.vornado.com

Speak your mind www.vornado.com/reviews
Hable con franqueza www.vornado.com/reviews
Évaluer ce produit en ligne www.vornado.com/reviews